













36 512 979



- forceful flat water jet
- horizontal water jet
- cover plate 240 x 60 mm
- water jet adjustable
- 1/2" connection
- max. flow 10 l/min
- WRAS 2005003
- This product can help a building meet the requirements of Green Building Rating Systems, e.g. LEED®, BREEAM®, DGNB

Fits: IMO, LULU, MADISON, MEM, TARA, CL.1, LISSÉ, VAIA, META, CYO

	Brushed Platinum	36 512 979-06
	Chrome	36 512 979-00
	Platinum	36 512 979-08
	Dark Chrome	36 512 979-19
	Light Gold	36 512 979-26
	Brushed Light Gold	36 512 979-27
	Brushed Durabrass (23kt Gold)	36 512 979-28
	Matte Black	36 512 979-33
	Brushed Bronze	36 512 979-42
	Brushed Champagne (22kt Gold)	36 512 979-46
	Champagne (22kt Gold)	36 512 979-47
	Brushed Chrome	36 512 979-93
	Brushed Dark Platinum	36 512 979-99

Required miscellaneous



- Concealed wall installation box - 35 206 970 90**
- max. recess depth 173 mm
 - min. recess depth 100 mm

Recommended miscellaneous



- xGRID Attachment set for integrating in the dry wall construction - 12 340 970 90**

Required miscellaneous



- xGRID Installation track 555 mm - 12 360 970 90**

36 512 979

mm [inches]

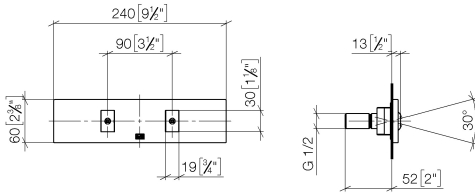

Flow rate chart

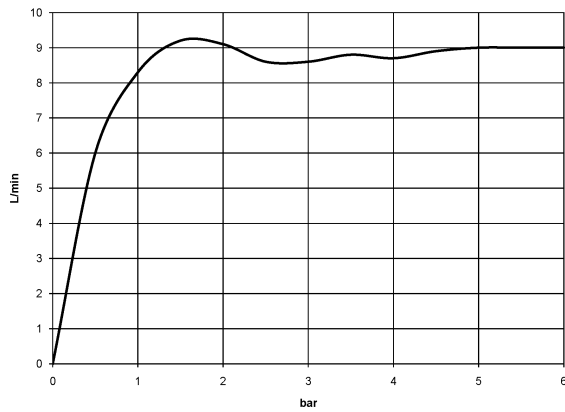

Trajectory diagram

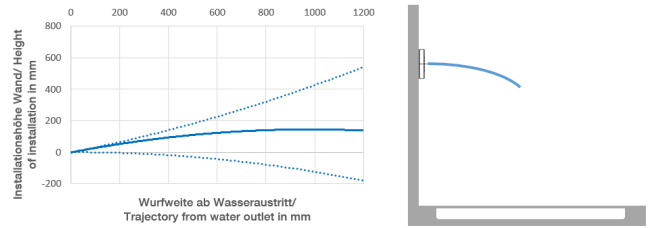

Certificates

LGA_29335.

WRAS_2005003.

36 512 979

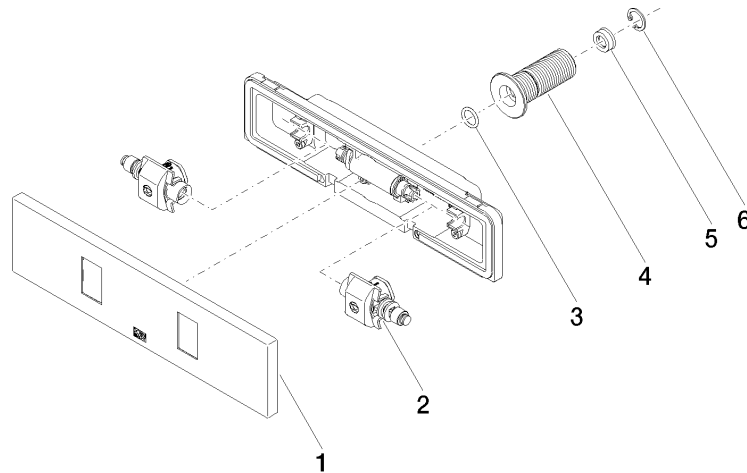

Spare parts list

No.	Item Number	Name	Quantity used	Delivery time
1	90 27 99 002 00-06	insert	1	10
2	90 31 10 012 00 90	insert	1	2
3	09 14 10 003 90	seal	1	2
4	09 24 05 015 90	nipple	1	2
5	09 23 01 134 90	flow reducer	1	2
6	09 16 01 014 90	ring	1	2